

Extraction



Contents

The behr range

for the extraction process _____ 4

Examples and guidelines _____ 6

Soxhlet extraction _____ 8

Complete single extraction units _____ 9

Series extraction devices _____ 10

Accessories for Soxhlet extractions _____ 12

Hot extraction according to Randall _____ 14

Manual apparatus and accessories _____ 15

Hot extraction according to Twisselmann _____ 16

Single extraction unit _____ 17

Series extraction devices and accessories _____ 17

Hydrolysis _____ 18

Hydrolysis unit and filtration unit _____ 18

Raw fibre separation _____ 19

Raw fibre separation and filtration unit _____ 19

Extraction for soil analysis _____ 20

Complete single extraction units _____ 20

Series extraction devices _____ 21

Determination of alcohol and volatile acid content _____ 22

Determination of the essential oils content _____ 24

Determination of the water content _____ 24

Reflux distillation _____ 25

Recirculating condenser _____ 26

The behr range for the extraction process



Extraction processes (more precisely: solid-liquid extraction process) are used to separate soluble components from a solid sample.

Examples:

- Determining the fat content in foods
- Determining an impurity (e.g. PCB, abandoned armaments) in soil samples
- Examining the components of natural substances.

Even brewing coffee is an extraction process. However, in the laboratory the focus is on completely dissolving the examined components from the sample under defined conditions and in a not necessarily diluted form. In the laboratory, solvents such as ligroin or hexane are used as extraction agents.

The objective of all extraction processes is to dissolve as much of the soluble components as possible with a specific amount of solvent. This is achieved by constantly vaporising the solvent and allowing it to drip into the sample from a reflux condenser. In contrast to a coffee machine, the same solvent is constantly sent back to the sample. The extracted component accumulates in the distillation flask.

Classic extraction: Soxhlet

The standard extraction method is the Soxhlet method. behr apparatus for Soxhlet extractions fulfil all the various requirements in everyday laboratory practice.

- Practical brackets for condensers and intermediate extraction pieces for safe storage between extractions
- Extractor sizes from 30 ml to 1000 ml
- Compact apparatus with one sample position
- Series extraction devices with 4 or 6 sample positions
- Extractors with specially developed siphon tubes (make: "Bröckerhoff") guarantee consistent results across all sample positions.
- Extractors with taps remove the need for additional distillation after the extraction
- Condensers with screw connections improve work safety
- The hydrolysis units (1, 4 or 6 sample positions) also enable acid digestion prior to extraction (determination of the total fat content according to Weibull and Stoldt).

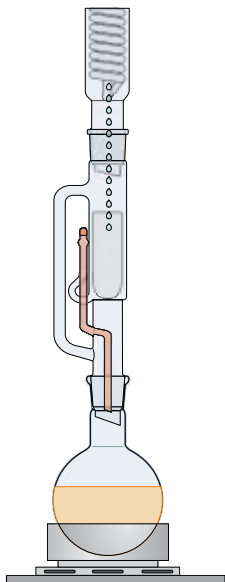

Hot extraction according to Randall

The hot extraction process according to Randall consists of three steps:

- Boiling
- Rinsing
- and evaporation.

Boiling

In the first step, the extraction thimble with the sample is located in the vessel with the boiling extraction agent - similar to a tea bag in a cup of hot water. Most of the substance to be extracted should dissolve in this step and is distributed in the solvent. The top part of the apparatus simply acts as a reflux condenser; the condensate drips into the extraction thimble and helps to dissolve the substance.

Rinsing

In the second step, the extraction thimble is lifted out of the pool. Extract may still adhere to the thimble; and some of the substance that has not yet dissolved may still be located in the sample. The condensate from the condenser flushes the remaining extract and progressively dissolves the previously undissolved portion. If the dissolved extract is to be subjected to further processing, the extraction is now complete. Otherwise, the solvent is removed in the third step.

Evaporation

Connect the recirculating tap to the condenser for evaporation. The condensate collects in the lower part of the condenser; it can be reused for the next extraction. Thanks to the short path to the apparatus, the sample can be evaporated until it is almost dry. Benefits of the hot extraction process include

- A compact apparatus with short process paths,
- Low solvent requirement,
- Short extraction period - typically about an hour.

Due to the short extraction period, hot extraction is also gentle on the extract. There are now also an increasing number of analysis processes that use hot extraction.

Hot extraction according to Twisselmann

In the Twisselmann process, the vessel in which the extraction thimble is placed is open at the bottom; the extract immediately flows back into the distillation flask. The extraction thimble is constantly rinsed by the solvent from above and hot steam circulates from below.

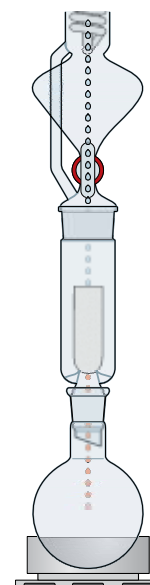
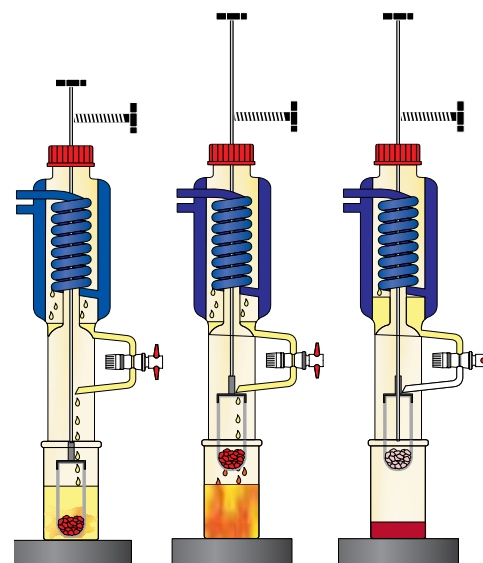

The "right" extraction for your task - examples



Are you looking to analyse encased and bound fat in food?

- Hydrolysis
- Then use the standard Soxhlet extraction, e.g. fat determination according to Weibull-Stoldt or the AOAC international hydrolysis method



Are you looking to determine the raw fat content in food and processed animal feed (with homogeneous composition)?

- Direct hot extraction according to Randall
- Hydrolysis to determine the total fat content for some samples prior to extraction if required



Are you looking to examine the composition of packaging material or consumer products? For example

- Hot extraction according to Randall to determine plasticisers in packaging
- Soxhlet extraction of organic compounds from plant tissue



Are you looking to analyse pesticide residues in grain products?

- Extraction of the residues and contaminants from food and fodder samples or other organic materials under inert conditions. The necessary detection limits are reached by higher sample weights

Guidelines

Glassware for Soxhlet extractions

Extraction	Round-bottomed flask	Flat-bottomed flask	Extractor	Condenser
30 ml	100 ml	-	30 ml	RFK 30
60 ml	250 ml	-	60 ml	RFK 60
100 ml	250 ml	250 ml	100 ml	RFK 100
250 ml	500 ml	-	250 ml	RFK 100
500 ml	1,000 ml	-	500 ml	RFK 500
1,000 ml	2,000 ml	-	1,000 ml	RFK 1000
2,000 ml	5,000 ml	-	2,000 ml	RFK 2000

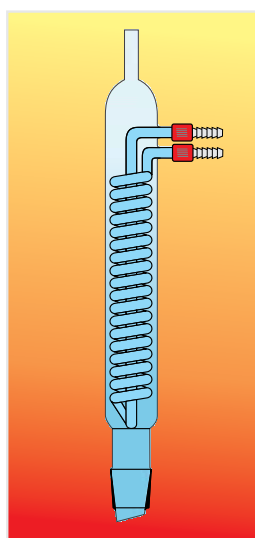

behr RFK extraction condenser

behr RFK extraction condensers ensure minimum solvent loss, even at higher room or cooling water temperatures.

- More coils
- Optimised condensing coil incline
- Maximum cooling surface
- Cooling connections with threaded fittings

RFK

Soxhlet extraction

Classic fat determination with Soxhlet extraction after hydrolysis

Hydrolysis principle

This acid digestion process dissolves both "free fats" as well as "bound fats" from the overall fat content.

The fat is frequently naturally enclosed in the cell matrix of the food or fodder or chemically bound. In these cases, a hydrolysis step before extraction completely releases the fat.



Hydrolysis-digestion units p. 18

The user filters the hydrolysate of the separated sample by using a glass sample tube filled with sand or Celite.

The user then rinses the fatty filter residue with water in order to remove the acid.

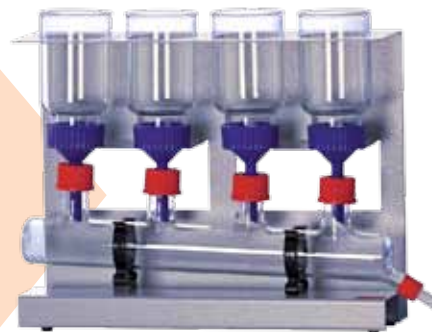

Filter equipment for hydrolysis p. 18

After drying, the filter residue is finally extracted.



Soxhlet extraction systems p. 9

Complete single extraction units

The standard extraction method is the Soxhlet method. behr apparatus for Soxhlet extractions fulfil all the various requirements in everyday laboratory practice.

- Practical brackets for condensers and intermediate extraction pieces for safe storage between extractions
- Extractor sizes from 30 ml to 1,000 ml
- Compact apparatus with one sample position
- Series extraction devices with 4, 6 or 8 sample positions
- Extractors with specially developed siphon tubes (make: "Bröckerhoff") guarantee consistent extraction cycles across all sample positions
- Extractors with taps remove the need for additional distillation after the extraction
- Condensers with threaded fittings

The behr hydrolysis units (4 or 6 sample positions) also enable acid digestion prior to extraction (determination of the total fat content according to Weibull and Stoldt).

Complete single extraction units

Complete single extraction units with base frame, heating device, bracket, tubes and glass apparatus (reaction flask, extractor, Dimroth condenser for extraction). Infinitely variable heating control. After the extraction cycle, the extractors with tap conduct the solvent directly into the dispensing bottle.

Includes extraction thimble and boiling chips in a sample pack.



KEX 100 F

Technical data the Soxhlet extraction

	KEX 100	KEX 250	KEX 500/1000
Voltage/Frequency	230 VAC/ 50/60 Hz		
Power consumption	450 W		1100 W
Weight	approx. 7.5 kg		approx. 8.5 kg
Dimensions in cm (W x D x H)	approx. 23 x 33 x 80		approx. 23 x 35 x 95

Complete single extraction units

Make	Item description	Item no.
KEX 60	for 60 ml extraction	B00441131
KEX 100	for 100 ml extraction	80 48 00521
KEX 250	for 250 ml extraction	80 48 00540
KEX 500	for 500 ml extraction	80 48 00542
KEX 60 F	for 60 ml extraction with tap	B00441132
KEX 100 F	for 100 ml extraction with tap	80 48 00522
KEX 250 F	for 250 ml extraction with tap	80 48 00536
KEX 500 F	for 500 ml extraction with tap	80 48 00543
KEX 1000 F	for 1,000 ml extraction with tap	B00441133

behrotest[®] series extraction devices

precisely aligned to your needs

- Cooling water distribution strip ensures uniform cooling at sample positions
- Practical condenser ledge to safely deposit the condenser between extractions
- Condensers with threaded fittings
- Drip tray
- Extractor sizes from 30 ml to 250 ml
- Extractors with specially developed siphon tubes guarantee consistent extraction cycles across all sample positions
- S models: Extractors with taps remove the need for additional distillation after the extraction
- PTFE tap no fixing, does not have to be greased
- Brackets for safely holding the intermediate extraction pieces after removing the sample container
- Series extraction devices with 4, 6 or 8 sample positions
- Every sample position can be individually adjusted

behrotest® series extraction devices

behrotest® series extraction devices are the cost-effective and user-friendly solution for classic Soxhlet and fat extractions:

- Complete with reaction vessels, intermediate extraction pieces and condensers
- Energy individually adjustable for every sample position
- Cooling water distribution strip ensures uniform cooling at sample positions
- Extractors with specially developed siphon tubes (make: "Bröckerhoff") guarantee consistent extraction cycles across all sample positions
- Practical condenser ledge to safely deposit the condenser between extractions
- Brackets for safely holding the intermediate extraction pieces after removing the sample container
- S models: Extractors with taps remove the need for additional distillation after the extraction

behrotest® series extraction devices - round-bottom flasks

Make	Sample positions	Tap	Extractor content ml	Item no.
R 604	4	-	60	80 48 80051
R 606	6	-	60	80 48 80052
R 604 S	4	+	60	80 48 80053
R 606 S	6	+	60	80 48 80054
R 104 S	4	+	100	80 48 80023
R 106 S	6	+	100	80 48 80022
R 108 S	8	+	100	B00441134
R 254 S	4	+	250	80 48 80033
R 256 S	6	+	250	80 48 80034

behrotest® series extraction devices - flat-bottom flasks

Make	Sample positions	Tap	Extractor content ml	Item no.
R 104 S-SK	4	+	100	B00585692
R 106 S-SK	6	+	100	B00520234
R 108 S-SK	8	+	100	B00600445

Technical data for the series extraction devices

	4 sample positions	6 sample positions	8 sample positions
Voltage	230 VAC		
Frequency	50/60 Hz		
Power consumption	1500 W	2250 W	3000 W
Power consumption	7 A	10 A	13 A
Weight (without glass)	approx. 15 kg	approx. 20 kg	approx. 25 kg
Dimensions in cm (W x D x H) (without glass)	approx. 53 x 32 x 74	approx. 76 x 32 x 74	approx. 90 x 32 x 74

100 ml extraction with flat-bot-tomed flask: Safe and practical

behr precision positioning cradles for flat-bottomed flasks ensure an extremely safe and simple workflow for a 100 ml extraction.

For conventional round-bottomed flasks

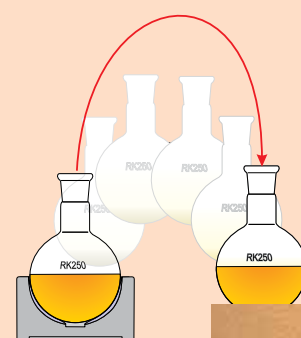
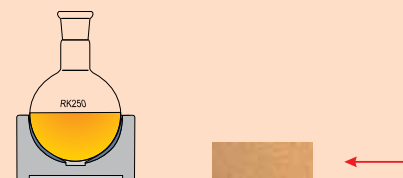

the user needs additional cork rings to position the flask on the working surface.

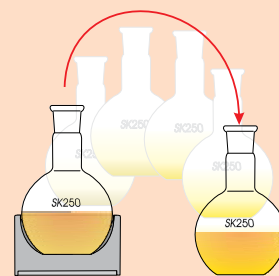

Flat-bottomed flasks can easily be placed on any flat surface.

Benefits:

- No additional material required (cork rings)
- No additional sample manipulation (positioning in the cork ring)
- Improved vessel stability



WABEX 425

Series extraction devices - with water bath for highly flammable solvents includes glassware and connection tubes

Make	Item description	Extractor content ml	Item no.
WABEX 410	4 sample positions simultaneously	100	B00513701
WABEX 425	4 sample positions simultaneously	250	B00513702
WABEX 610	6 sample positions simultaneously	100	B00513703
WABEX 625	6 sample positions simultaneously	250	B00513704

Technical data

	WABEX 410/425	WABEX 610/625
Dimensions in cm (H x W x D)	81 x 68 x 32	81 x 98 x 32
Weight (without glass)	15 kg	19 kg
Nominal voltage	230 V	230 V
Power consumption	1000 W	1500 W

Accessories for the Soxhlet extraction

Extractors

Make	Item description	Item no.
EZ 60	Soxhlet extractor, 60 ml	B00592289
EZ 60/H	Soxhlet extractor, 60 ml, with tap	B00592290
EZ 100	Soxhlet extractor, 100 ml	B00217967
EZ 100/H	Soxhlet extractor, 100 ml, with tap	B00217970
EZ 250	Soxhlet extractor, 250 ml	B00217974
EZ 250/H	Soxhlet extractor, 250 ml, with tap	B00217973
EZ 500	Soxhlet extractor, 500 ml	B00217980
EZ 500/H	Soxhlet extractor, 500 ml, with tap	B00217981
EZ 1000/H	Soxhlet extractor, 1,000 ml, with tap	B00373164

Extraction thimbles

Make	Item description	Item no.
EX 60 HS	for EZ 60 (EZ 60/H), package includes 25 units	B00600441
EX 100 HS	for EZ 100 (EZ 100/H), package includes 25 units	B00600442
EX 250 HS	for EZ 250 (EZ 250/H), package includes 25 units	B00217975
EX 500 HS	for EZ 500 (EZ 500/H), package includes 25 units	B00600462
EX 1000 HS	for EZ 1000/H, package includes 25 units	B00602316

Stands

Make	Item description	Item no.
RIP 4	for 4 extraction thimbles up to \varnothing 38 mm	B00602349
RIP 6	for 6 extraction thimbles up to \varnothing 38 mm	B00602350



EZ 100/H



EX 100 HS

PTFE sleeves

Make	Item description	Item no.
PTFE 34	PTFE sleeves for 60 ml extractors	B00602392
PTFE 45	PTFE sleeves for 100 ml and 250 ml extractors	804830450
PTFE 60	PTFE sleeves for 500 ml extractors	B00602391
PTFE 71	PTFE sleeves for 1,000 ml extractors	B00602374

Round-bottomed flask

Make	Item description	Item no.
RK 250	250 ml, for 60 ml and 100 ml extraction, (NS 29/32)	B00218499
RK 500	500 ml, for 250 ml extraction, (NS 29/32)	B00218500
RK 1000	1,000 ml, for 500 ml extraction, (NS 29/32)	B00218502
RK 2000	2,000 ml, for 1,000 ml extraction, (NS 29/32)	B00114580



RK 250

Flat-bottomed flask

Make	Item description	Item no.
SK 250	250 ml, for 100 ml extraction	B00491162



RK 250
in positioning cradle
AM 250/941

Reflux condensers

Make	Item description	Item no.
RFK 60	for 60 ml extractors	B00592291
RFK 100	for 100 ml and 250 ml extractors	B00218214
RFK 500	for 500 ml extractors	B00217972
RFK 1000	for 1,000 ml extractors	B00602310

Positioning cradles

Make	Item description	Item no.
AM 100/94	for 100 ml round-bottomed flasks including spacing inlay	B00217701
AM 250/941	for 250 ml round-bottomed flasks with integrated spacer bars	B00231006
AM 250/942	for 250 ml flat-bottomed flasks with integrated spacer bars	B00441225
AM 500/941	for 500 ml round-bottomed flasks with integrated spacer bars	B00231007
AM 1000/145	for 1,000 ml round-bottomed flasks including spacing inlay	B00441114



SK 250
in positioning cradle
AM 250/942



Hot extraction according to Randall

for faster extraction



E4

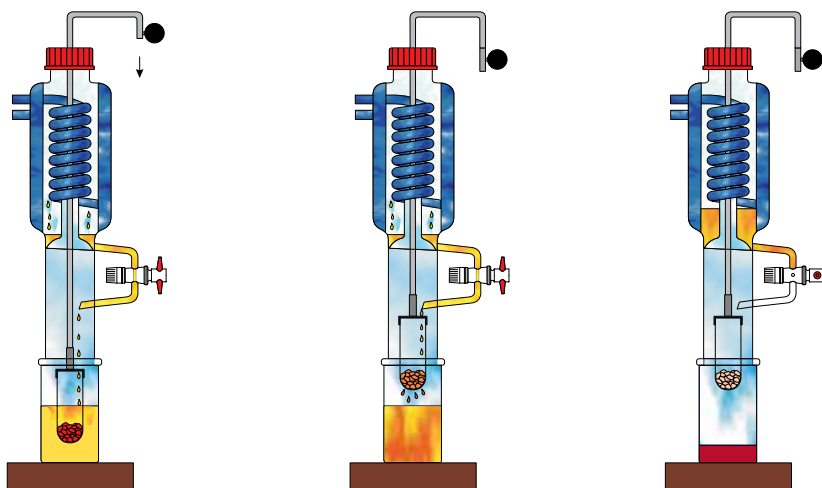

Immerse

Wash

Dry

Manual apparatus for hot extraction according to Randall. Several times faster than a customary Soxhlet extraction. Incl. 1 set of extraction thimbles, 100 ml.

- Optimal safety thanks to screw-fastened extraction units

Multiple position extraction units:

- Every extraction thimble with sample can be independently adjusted
- The user can lower and raise all the extraction units into/out of the heating chamber with a single lever
- Every heating position has a separate temperature control

Manual apparatus according to Randall

Make	Item description	Item no.
E1	One sample position	80 48 80048
E4	Four individually adjustable sample positions	80 48 80049
E6	Six individually adjustable sample positions	80 48 80050
EX 75 HS	Matching extraction thimbles for the EB 75 reaction flask	B00600441
EB 75	Reaction flask	B00231976
SIST 100	Boiling chips, 100 g	B00217914

Stands

Make	Item description	Item no.
RIP 475	for 4 reaction flasks	B00602351
RIP 675	for 6 reaction flasks	B00602352

Technical data

	E 1	E 4	E 6
Number of sample positions	1	4	6
Dimensions (W x D x H)	23 x 27 x 60 cm	55 x 42 x 67 cm	85 x 42 x 67 cm
Weight	6 kg	34 kg	50 kg
Nominal voltage	230 V~, 50/60 Hz		
Nominal power	360 W	1440 W	2160 W
Solution volume	60 ml; max 75 ml		



E1



RIP 675

Extraction

according to Twisselmann



R 106 T

The extraction according to Twisselmann is a continuous hot extraction. It functions in a similar manner to the Soxhlet extraction. However, the temperature in the sample in the Twisselmann extractor is extremely hot, i.e. close to the solvent's boiling point. This improves solubility and shortens the extraction time.

The higher extraction temperature results from the condensed solvent flowing through the extraction thimble from above mixing with the rising, hot solvent vapour from below. The temperature of the mixture is much higher than that of the condensed solvent.

The Twisselmann extraction reduces the extraction time by up to 50% compared to the Soxhlet extraction.

Single extraction unit for hot extraction according to Twisselmann

Complete single extraction unit with base frame, heating device, bracket, tubes and glass apparatus (reaction flask, extractor, Dimroth condenser for extraction) as well as a sample pack with extraction thimbles and boiling chips.

Make	Item description	Item no.
KEX 100 T	Single extraction unit for hot extraction according to Twisselmann	80 48 00537

behrotest® series extraction devices for hot extraction according to Twisselmann

Cost-effective and user-friendly apparatus for hot extraction according to Twisselmann

- Energy individually adjustable for every sample position
- Cooling water distribution strip ensures uniform cooling at sample positions
- Practical condenser ledge to safely deposit the condenser between hot extractions
- Brackets for safely holding the intermediate extraction pieces after removing the sample container

behrotest® series extraction devices for hot extraction according to Twisselmann - round-bottomed flasks

Make	Item description	Item no.
R 104 T	Complete for 4 positions simultaneously with 250 ml round-bottomed flasks	80 48 80045
R 106 T	Complete for 6 positions simultaneously with 250 ml round-bottomed flasks	80 48 80043

behrotest® series extraction devices for hot extraction according to Twisselmann - flat-bottomed flasks

Make	Item description	Item no.
R 104T-SK	Complete for 4 positions simultaneously with 250 ml flat-bottomed flasks	B00521010
R 106T-SK	Complete for 6 positions simultaneously with 250 ml flat-bottomed flasks	B00521009

Accessories for extractions

Make	Item description	Item no.
EZT	Extractor, 100 ml, for the Twisselmann extractors	80 48 41043
PTFE 45	PTFE sleeves for 100 ml and 250 ml extractors	80 48 30450
RFKT	Condenser for 100 ml Twisselmann extractors	80 48 41044

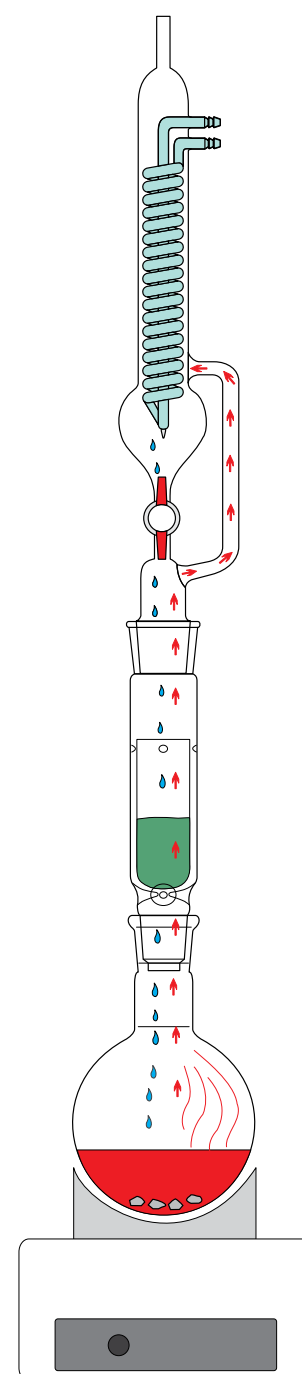

Hydrolysis

Sample preparation for the extraction



EXR 6

The Weibull-Stoldt method

The quantitative determination of the fat content of food is performed by extraction with a solvent. The "free fat" is determined by direct extraction. The "total fat content" includes both the "free fat" and the "bound fats" that are dissolved by acid digestion (hydrolysis).

behrotest® hydrolysis unit for acid digestion

Hydrolysis-digestion apparatus with 4 or 6 sample positions.

Complete with:

- 600 ml beaker
- Water-cooled condenser with cool water distribution
- Condenser stand with drip tray
- Heating positions individually infinitely adjustable
- Main power switch with pilot light

Fully assembled complete device with all the necessary accessories.

behrotest® hydrolysis unit for acid digestion

Make	Item description	Item no.
EXR 4	Hydrolysis unit, 4 sample positions	804880044
EXR 6	Hydrolysis unit, 6 sample positions	804880046

behrotest® filtration unit made of borosilicate glass

Complete with:

- Filtration attachment, 400 ml, threaded
- PP funnel, threaded
- Sieve plate with 2 seals
- Stainless steel frame
- PP water suction pump
- Tweezers
- Vacuum hose

Filtration unit for hydrolysis

Make	Item description	Item no.
FU 4	Filtration unit for hydrolysis with 4 positions	B00441135
FU 6	Filtration unit for hydrolysis with 6 positions	B00441144

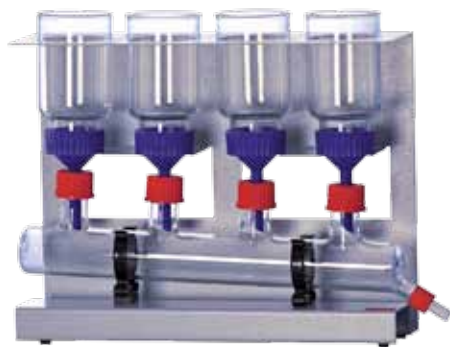

FU 4

Raw fibre separation

behrotest® apparatus for raw fibre separation

Raw fibre separation apparatus with 4 or 6 sample positions.

Complete with:

- 600 ml beaker
- Water-cooled condenser with cool water distribution
- Condenser stand with drip tray
- Heating positions individually infinitely adjustable
- Main power switch with pilot light

Fully assembled complete device with all the necessary accessories.

behrotest® apparatus for raw fibre separation

Make	Item description	Item no.
EXR 4	with 4 sample positions	80 48 80044
EXR 6	with 6 sample positions	80 48 80046



EXR 6

behrotest® filtration unit for raw fibre separation

Filtration unit for raw fibre separation with 4 or 6 sample positions.

Complete with:

- Filter crucible
- Filtration advancers
- Seals
- Connection fittings
- Drainage pipe with connecting nozzle for vacuum or water suction pump

e.g. to determine the raw fibre content according to EN ISO6865

Filtration unit for raw fibre separation

Make	Item description	Item no.
SC 4	with 4 positions	B00513779
SC 6	with 6 positions	B00513780

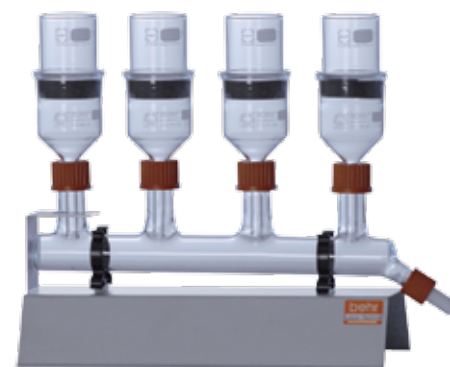

SC 4

MVP 46 - complete extraction unit for SC 4 and SC 6

Complete with:

- Diaphragm vacuum pump
- 2 ltr. collection bottle
- Tubes

Make	Item description	Item no.
MVP 46	Complete extraction unit	B00515390



MVP 46

Extraction

for soil analysis



KEX 30

The standard extraction method for soil analysis is also the Soxhlet method. The Soxhlet apparatus for Soxhlet extractions fulfil all the various requirements in everyday laboratory practice.

- Practical brackets for condensers and intermediate extraction pieces for safe storage between extractions
- Extractor sizes from 30 ml to 100 ml
- Single extraction units with one sample position
- Series extraction devices with 4, 6 or 8 sample positions
- Extractors with specially developed siphon tubes (make: "Bröckerhoff") guarantee consistent extraction cycles across all sample positions
- Extractors with taps remove the need for additional distillation after the extraction
- Condensers with threaded fittings

Complete single extraction units

Complete single extraction units with base frame, heating device, bracket, tubes and glass apparatus (reaction flask, extractor, Dimroth condenser for extraction). Infinitely variable heating control. After the extraction cycle, the extractors with tap conduct the solvent directly into the dispensing bottle. Includes extraction thimbles and boiling chips in a sample pack.

Complete single extraction units

Make	Item description	Item no.
KEX 30	30 ml extraction	80 48 00520
KEX 30 F	30 ml extraction with tap	80 48 00541
KEX 100	100 ml extraction	80 48 00521
KEX 100 F	100 ml extraction with tap	80 48 00522

Technical data for the single extraction unit

	KEX 30
Voltage/Frequency	230 VAC/ 50/60 Hz
Power consumption	450 W
Weight	approx. 7.5 kg
Dimensions in cm (W x D x H)	approx. 23 x 33 x 71.5

Accessories for 30 ml extractions

Make	Item description	Item no.
EZ 30	Soxhlet extractor, 30 ml	80 48 41031
EZ 30/H	Soxhlet extractor, 30 ml, with tap	80 48 41042
EX 30 HS	Extraction thimbles for EZ 30, package includes 25 units	80 48 41033
PTFE 29	PTFE sleeves for 30 ml extractors, package includes 12 units	80 48 30290
RK 100	Round-bottom flask, 100 ml, for 30 ml extractions, (NS29/32)	B00218501
RFK 30	Reflux condenser for 30 ml extractions	B00217955

behrotest® series extraction devices

behrotest® series extraction devices are the cost-effective and user-friendly solution for classic Soxhlet and fat extractions:

- Complete with reaction vessels, intermediate extraction pieces and condensers
- Energy individually adjustable for every sample position
- Cooling water distribution strip ensures uniform cooling at sample positions
- Extractors with specially developed siphon tubes (make: "Bröckerhoff") guarantee consistent extraction cycles across all sample positions
- Practical condenser ledge to safely deposit the condenser between extractions
- Brackets for safely holding the intermediate extraction pieces after removing the sample container
- S models: Extractors with taps remove the need for additional distillation after the extraction

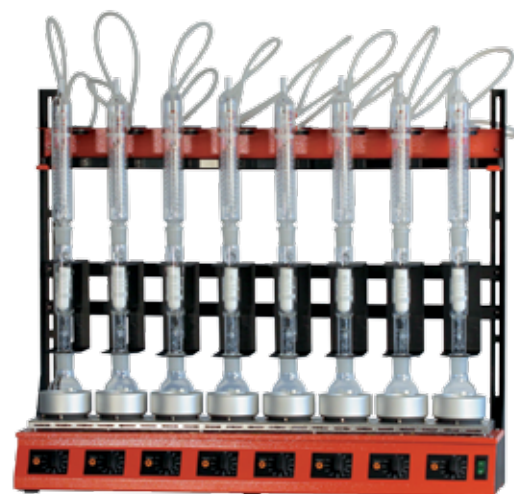

R 308

behrotest® series extraction devices - round-bottom flasks

Make	Sample positions	Tap	Extractor content ml	Item no.
R 304	4	-	30	804880031
R 306	6	-	30	804880032
R 308	8	-	30	B00602363
R 304 S	4	+	30	804880041
R 306 S	6	+	30	804880042
R 308 S	8	+	30	B00602364
R 104 S	4	+	100	804880023
R 106 S	6	+	100	804880022
R 108 S	8	+	100	B00441134

behrotest® series extraction devices - flat-bottom flasks

Make	Sample positions	Tap	Extractor content ml	Item no.
R 104 S-SK	4	+	100	B00585692
R 106 S-SK	6	+	100	B00520234
R 108 S-SK	8	+	100	B00600445

Accessories for 100 ml extractions

Make	Item description	Item no.
EZ 100	Soxhlet extractor, 100 ml	B00217967
EZ 100/H	Soxhlet extractor, 100 ml, with tap	B00217970
EX 100 HS	Extraction thimbles for EZ 100, package includes 25 units	804841034
PTFE 45	PTFE sleeves for 100 ml extractors	804830450
RK 250	Round-bottom flasks, 250 ml, for 100 ml extraction	B00218499
RFK 100	Reflux condenser for 100 ml extractions	B00218214
AM 100/94	for 100 ml round-bottomed flasks including spacing inlay	B00217701

Determination of the alcohol and volatile acid content



D 1

Steam distillation units D 1 and D 2

- Alcohol
- Organic acids SOS
- Beer fermentation process
- Ammonium chloride in liquorice products

Apparatus for determining the alcohol content and the volatile acids in wine and other alcoholic drinks. Complete glassware set with volumetric flask and pycnometer. behr D 1 and D 2 are particularly well suited for high sample throughputs due to their speed.

The supplied Windows software allows a bidirectional transmission of application-specific distillation parameters using the RS232 interface between one or more devices and a PC. A library with current applications is already included on the CD. The RS232 interface also allows data to be transmitted from the device to the PC during operation. The user can save the data and print it as required.

Make	Item description	Item no.
D 1	Steam distilling apparatus for determining the alcohol content, distillation in a pycnometer	80 48 49010
D 2	Steam distilling apparatus for determining organic acids, distillation in a 500 ml Erlenmeyer flask	80 48 49011

Technical data for behr D 1

Dimensions in cm (W x H x D)	approx. 41 x 67.5 x 41	
Weight	approx. 32 kg	
Nominal voltage	230 VAC	50 Hz/ 60 Hz
Power consumption	1700 W	9 A/ 18 A
Cooling water consumption	approx. 5 l/min	
Storage container	any size, recommendation: behrotest® canister set	
Display	LCD	
Programs	1	



Determination of the essential oil content



KOL

Compact system for determining the essential oil content

Complete compact system for determining the essential oil content in

- Pharmaceuticals,
- Spices
- Seasoning and
- Herbs

according to ISO 6571.

With base frame, heating devices, brackets, coolant hoses and glass apparatus.

Compact system for determining the essential oil content

Make	Item description	Item no.
KOL	with 500 ml flask	80 48 00539
KOL 2	with 1,000 ml flask	B00602393

Complete compact system for determining the essential oil content in citrus fruits and their derivatives according to Clevenger (3,000 ml distillation flask).

Make	Item description	Item no.
CLE	Compact system for determining the essential oils in citrus fruits and their derivatives	80 48 00544

Water content

Water content



KWA 500

Compact system for determining the water content by azeotropic distillation

Complete compact system for determining the water content by azeotropic distillation. Suitable for inhomogeneous, bulky food such as dried fruit, sauerkraut, etc. With base frame, heating device, bracket and glass apparatus.

Make	Item description	Item no.
KWA 500	behrotest® compact apparatus for determining the water content. Complete with stand, glassware set, heating and hose connections	80 48 00500

Reflux distillation

Reflux distillation apparatus

Complete apparatus for reflux distillation, consisting of

- Hot bar, 4 heating positions
- Positioning cradles
- Support rods
- Cooling water distribution with condenser support panel and condenser brackets
- Reaction flask
- behr high-performance glass coolers

Series reflux distillation apparatus

Make	Item description	Item no.
RH 104	4 heating positions for 100 ml round-bottomed flasks, complete	B00602394
RH 106	6 heating positions for 100 ml round-bottomed flasks, complete	B00602397
RH 254	4 heating positions for 250 ml round-bottomed flasks, complete	B00602395
RH 256	6 heating positions for 250 ml round-bottomed flasks, complete	B00602398
RH 504	4 heating positions for 500 ml round-bottomed flasks, complete	B00602396
RH 506	6 heating positions for 500 ml round-bottomed flasks, complete	B00602399



RH 256

Technical data for reflux distillation apparatus

	4 sample positions	6 sample positions
Voltage	230 VAC	
Frequency	50/60 Hz	
Power consumption	1500 W	2250 W
Power consumption	7 A	10 A
Weight (without glass)	approx. 15 kg	approx. 20 kg
Dimensions in cm (W x D x H) (without glass)	approx. 53 x 32 x 74	approx. 76 x 32 x 74

Single reflux distillation apparatus

Complete apparatus for reflux distillation, consisting of

- Complete frame with condenser support panel and condenser bracket
- Positioning cradle
- Reaction flask
- behr high-performance glass cooler
- Tubing

Single reflux distillation apparatus

Make	Item description	Item no.
KRD 50	1 heating position for 50 ml round-bottomed flasks, complete	B00602400
KRD 100	1 heating position for 100 ml round-bottomed flasks, complete	B00602401
KRD 250	1 heating position for 250 ml round-bottomed flasks, complete	B00602402
KRD 500	1 heating position for 500 ml round-bottomed flasks, complete	B00602403
KRD 1000	1 heating position for 1,000 ml round-bottomed flasks, complete	B00602404



KRD 100

Recirculating condenser

The UK series



UK 1020

behrotest® UK recirculating condenser

behrotest® UK series recirculating condensers are ideally suited for use with the behr separation and distillation systems. The new and improved successor models of our UK 12 series are just as reliable and suitable for everyday use as their predecessors, but their performance has improved by 20%.

They are also generally suited

- as replacements for condensing systems that are cooled using domestic water
- for the dissipation of process heat
- for the thermostatic control of apparatus such as centrifuges, microscopes, spectrometers, analysers, distillation apparatus, rotary evaporators, electrophoresis, reaction vessels

All recirculating condensers can be used as a closed or open system.

Features:

- Electronic temperature control with LED display
- Float switch to monitor the coolant level
- Limit alarm if the permitted field of activity is exceeded
- Cooling unit: quiet, fully hermetic, air-cooled, low-maintenance
- 12 mm internally threaded tube connections (M10 x 1)
- 3/4" filler spout with vent valve on the surface of the device
- Stainless steel housing parts
- Non-ferrous metal heat exchanger
- Circumferential skirting protection rings both top and bottom
- UK 2020 has a cooling unit with two separately operating cooling circuits. This provides better setting options and the opportunity of emergency operation with the second machine if a compressor fails.

Make	Item description	Item no.
UK 420	380 watt cooling capacity with circulating pump and digital temperature control for regulating the temperature and cooling individual or several apparatus	B00602390
UK 620	580 watt cooling capacity with circulating pump and digital temperature control for regulating the temperature and cooling individual or several apparatus	B00602387
UK 1020	1200 watt cooling capacity with circulating pump and digital temperature control for regulating the temperature and cooling individual or several apparatus	B00602388
UK 2020	2200 watt cooling capacity with circulating pump and digital temperature control for regulating the temperature and cooling several apparatus	B00602389

Technical data

	UK 420	UK 620
Cooling capacity in watts		
at +21°	380	580
at +11°	270	480
at +6°		180
Operating range	+5° to +40° C	+5° to +40° C
Recirculating pump		
Output	4 l/min	12 l/min
Discharge head	1.5 mWs	6 mWs
Electr. connection		
Volt	230	230
Hz	50	50
Amp	1,5	2,8
External dimensions in cm (W x L x H)	approx. 26 x 37 x 40	approx. 31 x 36 x 52
Weight	approx. 18.2 kg	approx. 32 kg
Coolant container	4.0 l	2.6 l

	UK 1020	UK 2020
Cooling capacity in watts		
at +21°	1200	2200
at +11°	1000	1800
at +6°	700	1200
Operating range	+5° to +40° C	+5° to +40° C
Recirculating pump		
Output	12 l/min	12 l/min
Discharge head	26 mWs	30 mWs
Electr. connection		
Volt	230	230
Hz	50	50
Amp	3,5	8,0
External dimensions in cm (W x L x H)	approx. 34 x 40 x 60	approx. 44 x 47 x 76
Weight	approx. 41 kg	approx. 80 kg
Coolant container	4.6 l	9.0 l

This may also interest you



Extraction units for extracting liquids

Determination of the nitrogen content according to Kjeldahl:

- Infrared digestion devices with manual operation and also programmable
- Block digestion unit, also with fully-automatic lift
- Steam distillation units for (almost) any requirement
- Titration devices

The complete range for the CSB titration method:

- Dosing units for sulphuric acid, manual and also programmable
- Digestion units with fully-automatic time/temperature profile for standardised CSB determination
- Titrators, manual and fully-automatic, also as dosing-titrating combination

Fully-automatic analysers for determining the halogen content

- High-precision analytics by using an oven unit with programmable infrared oven and resistance oven with fixed temperature
- High degree of automation due to sampler for sample preparation and sample injection



behr Labor-Technik GmbH • Spangerstraße 8 • 40599 Düsseldorf
Tel.: (+49) (0) 211 – 7 48 47 17 • Fax: (+49) (0) 211 – 7 48 47 48
Email: info@behr-labor.com • Internet: www.behr-labor.com



Subject to technical changes and errors.